



alumawall

Stackable sleeper

An extruded aluminium stackable plinth/sleeper designed to be used both as a plinth under steel panel fences or as a retaining wall sleeper.

- › Fits neatly into 'C' section posts of common steel panel fencing brands
- › Perfect for preventing weeds or debris from protruding through gaps in fence
- › Can also be used to level or increase the base height of the fence
- › 2385mm long x 150mm high x 50mm wide - check your 'C' section posts to ensure correct fitting
- › Specially designed heavy duty post available for retaining wall installations

Key benefits:

- › Sturdy aluminium design with a high quality powder coat finish
- › Easily width adjustable - simply cut Alumawall stackable sleeper to desired width
- › Unique design where bottom of sleeper clips onto next sleeper ensuring straight seamless finish
- › Alumawall fits easily into most 'C' section posts for easy install
- › Ideal solution for garden edging
- › Can be used as a retaining wall system by using our engineered post system

Colours available:

Primrose **AWALL-2385-P**

Paperbark **AWALL-2385-PB**

Woodland Grey **AWALL-2385-G**

Monument **AWALL-2385-MN**



ALUMAWALL STACKABLE SLEEPERS

UNDER STEEL PANEL FENCES

How to install:

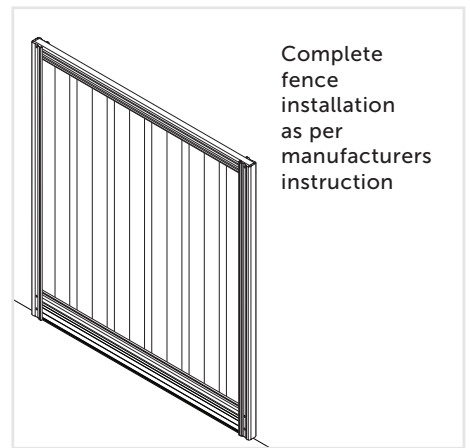
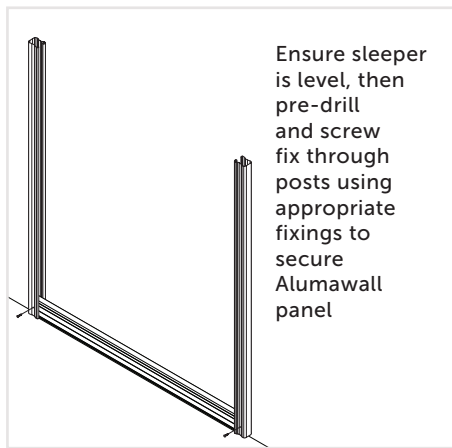
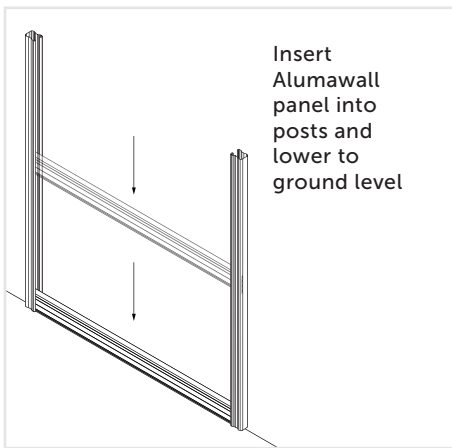

Easily stackable!

1 SLEEPER
150mm high

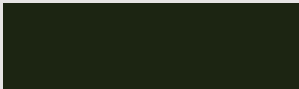

2 SLEEPERS
280mm high

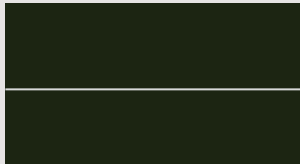

3 SLEEPERS
410mm high

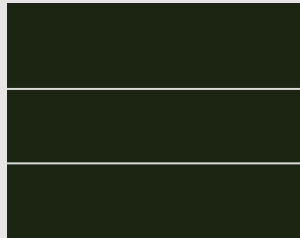

4 SLEEPERS
540mm high

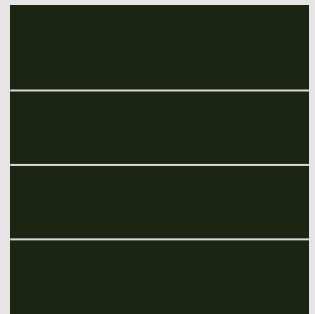



alumawall

- Retaining wall system -

Create a retaining wall with our new heavy duty retaining wall posts and sleepers.

Stackable sleeper

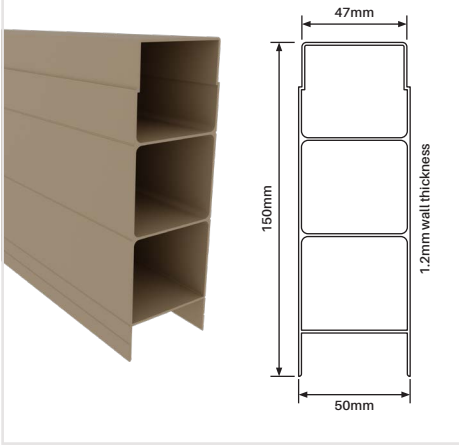



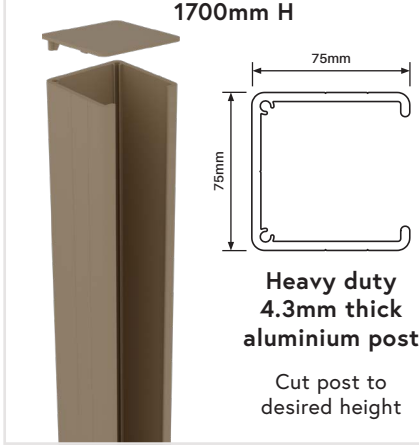

Retaining wall post
1700mm H



Posts are colour matched to sleepers. All material is durable powder coated aluminium. Walls up to 800mm high may be quickly and easily constructed. Contact us for engineering information.

FAST, EASY, EFFECTIVE.

- | | | |
|---|---------------|--------------------------------|
|  | Primrose | AWALL-2385-P (Sleeper) |
| | | AWALL-1700-1W-P (Post) |
|  | Paperbark | AWALL-2385-PB (Sleeper) |
| | | AWALL-1700-1W-PB (Post) |
|  | Woodland Grey | AWALL-2385-G (Sleeper) |
| | | AWALL-1700-1W-G (Post) |
|  | Monument | AWALL-2385-MN (Sleeper) |
| | | AWALL-1700-1W-MN (Post) |

Easily adaptable for 1 way, 2 way and 90° corner configurations

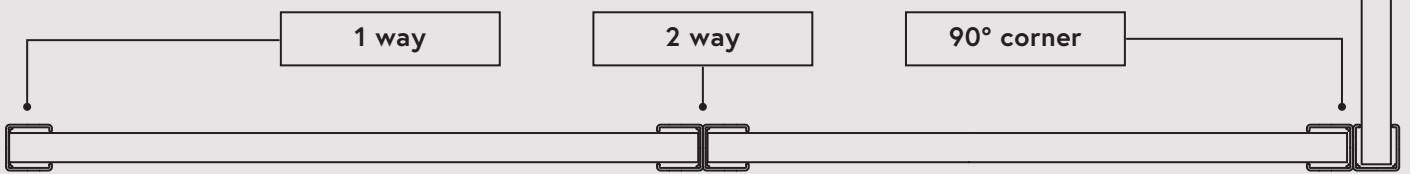

To join posts for 2 way or corner configurations, simply screw together using 15mm x 10G self tapping screws



IMPORTANT!

Engineering must be considered.
Contact us for relevant paperwork